

**81.19**

A P.R. 808

R.1123

**81.19**

A P.R. 808

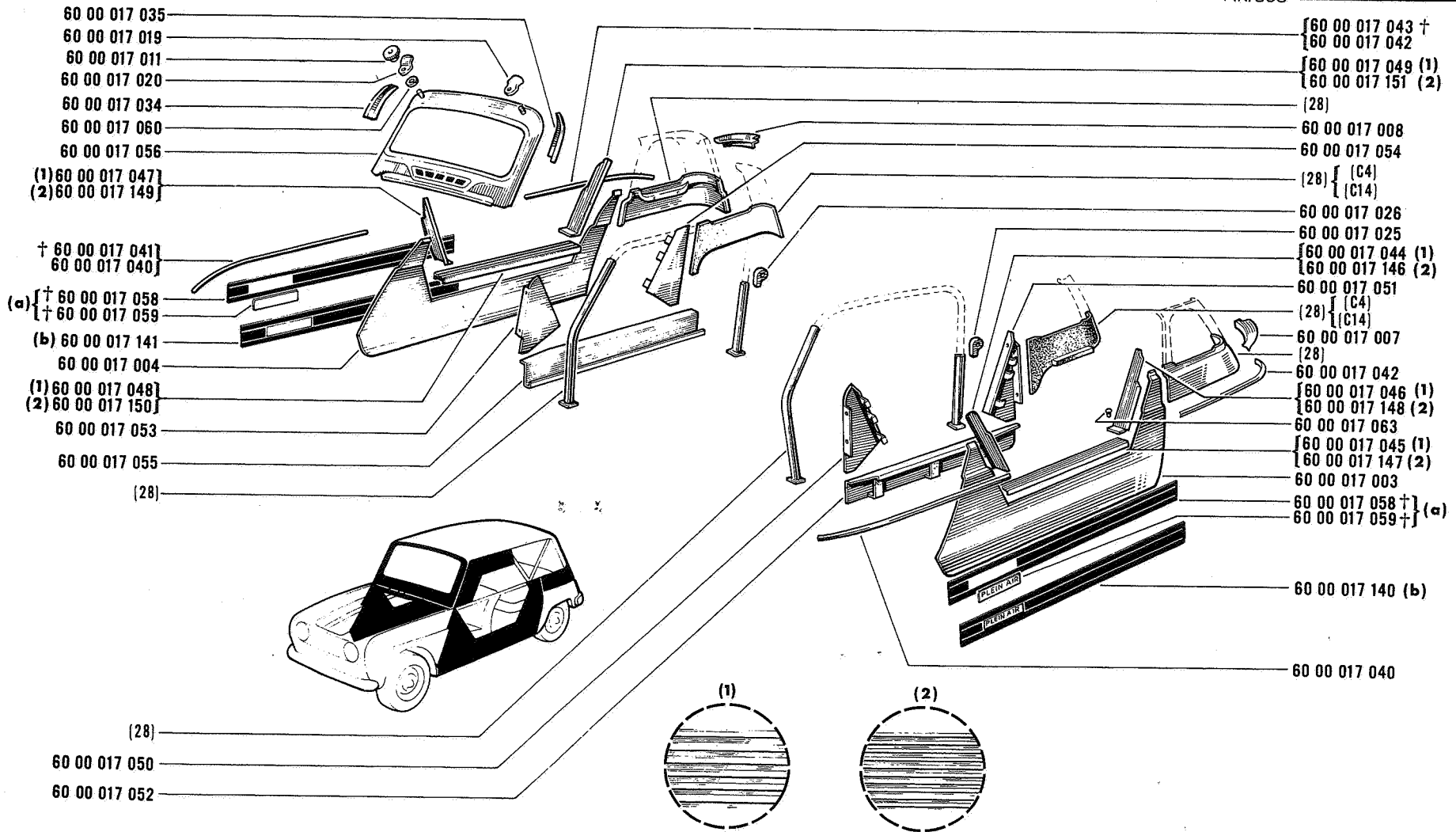
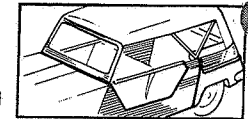

(a) R.1123 VEH n° 1 ⇨ VEH n° 578499 ✗ [130] ✗ [131]  
 (b) R.1123 VEH n° 578500 ⇨ VEH n° ... ✗ [131] ✗ [130]

[C4] [C14] 100-01

(28) 06...  
 (130) 08...  
 (131) 08...

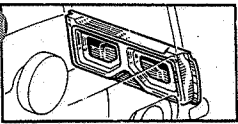

**82.75**

A P.R. 808

R.1123 

**82.75**

A P.R. 808

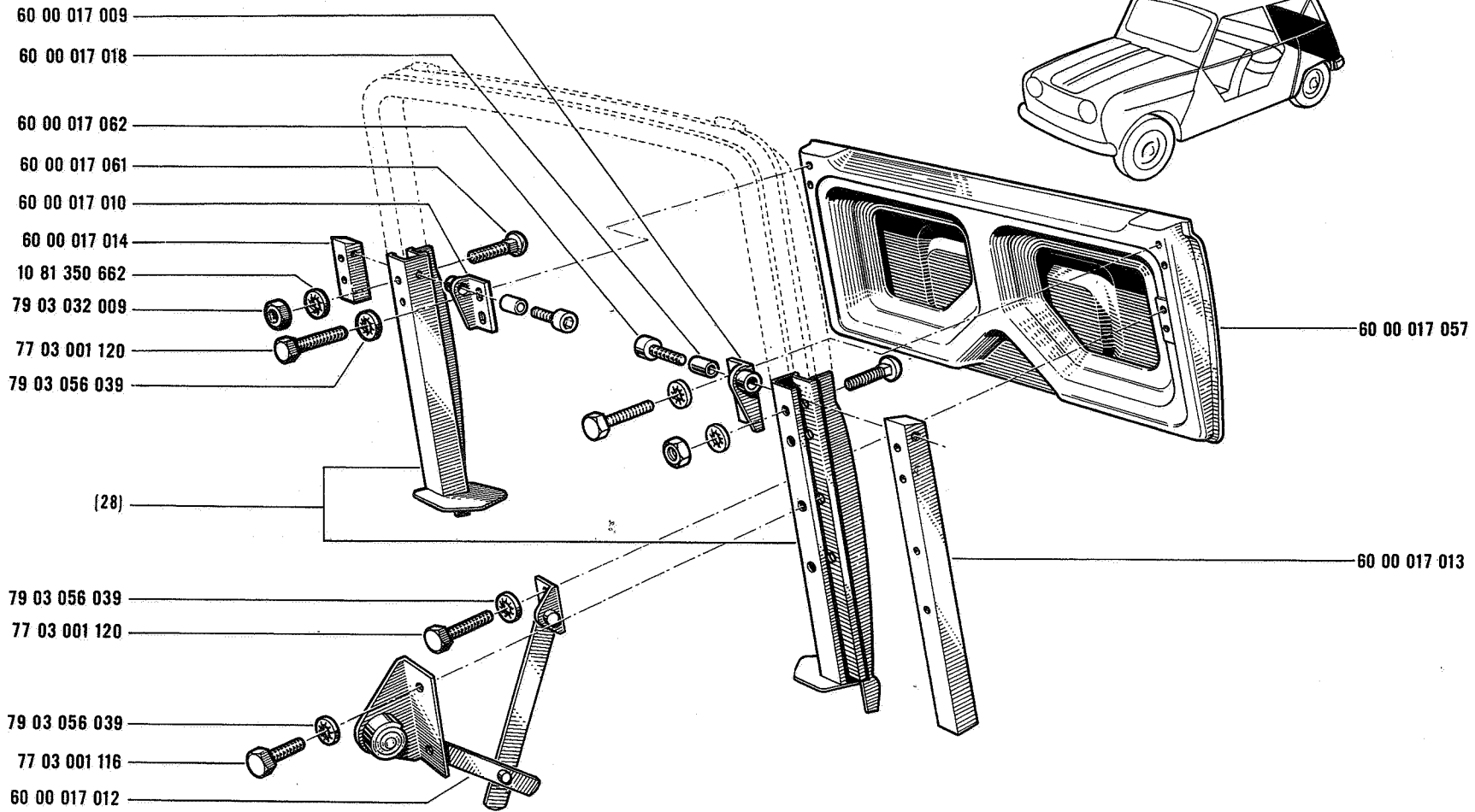
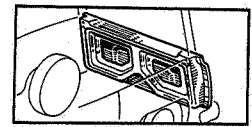

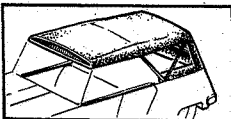

**84.65**

A P.R. 808

R.1123

**84.65**

A P.R. 808

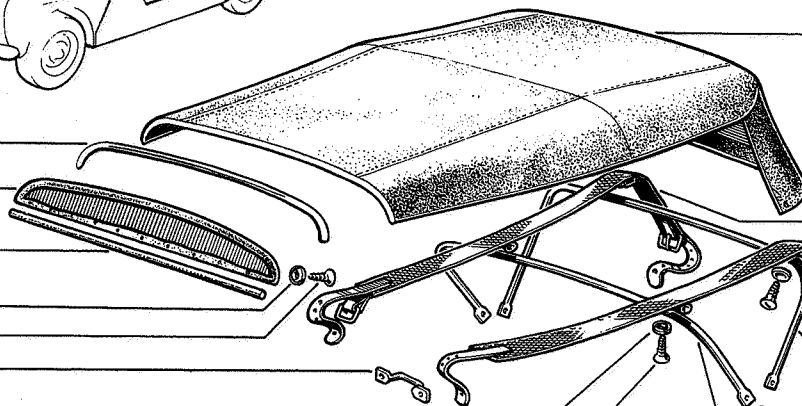
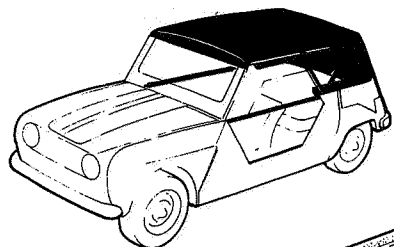
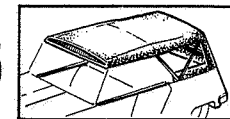

{ 60 00 017 100 (C4)  
60 00 017 101 (C10)

{ 60 00 017 144 (C4)  
60 00 017 145 (C10)

{ 60 00 017 102 (C4)  
60 00 017 103 (C10)

77 03 016 065

60 00 017 106

60 00 017 105

60 00 017 118

60 00 017 119

60 00 017 104

60 00 017 123

{ 60 00 017 107 (S21)  
60 00 017 108 (S29)

{ 60 00 017 109 (S21)  
60 00 017 110 (S29)

60 00 017 121

60 00 017 120

77 03 016 065

60 00 017 114

60 00 017 115

60 00 017 021

(P1) 60 00 017 031

(28)

60 00 017 120

77 03 016 065

60 00 017 106

60 00 017 120

77 03 016 063

79 03 056 003

60 00 017 122

{ (S 21) 60 00 017 111 }

{ (S 29) 60 00 017 112 }

60 00 017 117

60 00 017 033

60 00 017 113

(b) { 60 00 017 142

60 00 017 143

{ 77 03 016 065

(a) { 60 00 017 116

(a) R.1123 VEH n° 1 ⇨ VEH n° 598654 ☒ [132]

(b) R.1123 VEH n° 598655 ⇨ VEH n° ... ☒ [132]

(P1) (S21) (S29) 84 ...

(C4) (C10) 100-01

(28) 06 ...

(132) 08 ...

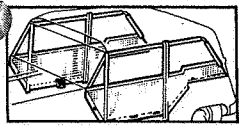

**84.66**

A P.R. 808

R.1123 

**84.66**

A P.R. 808

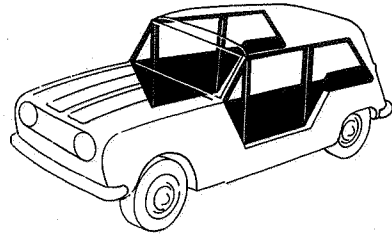
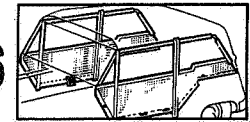

60 00 017 130

60 00 017 138

60 00 017 131

60 00 017 133

60 00 017 127

60 00 017 125

60 00 017 155

60 00 017 132

77 03 016 064

60 00 017 126

[ 60 00 017 153 (a)  
60 00 017 129 (b)

60 00 017 156

60 00 017 137

80 70 050 402

[ 60 00 017 154 (a)  
60 00 017 128 (b)

60 00 017 136

60 00 017 124

77 03 016 065

60 00 017 135

60 00 017 134

80 71 030 100

(a) R.1123 VEH n° 1 ⇨ VEH n° 598654 ☒ (132)

(b) R.1123 VEH n° 598655 ⇨ VEH n° ... ☒ (132)

{132}  08 ...

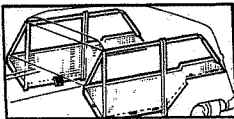

**84.67**

A P.R. 808

R.1123 

**84.67**

A P.R. 808

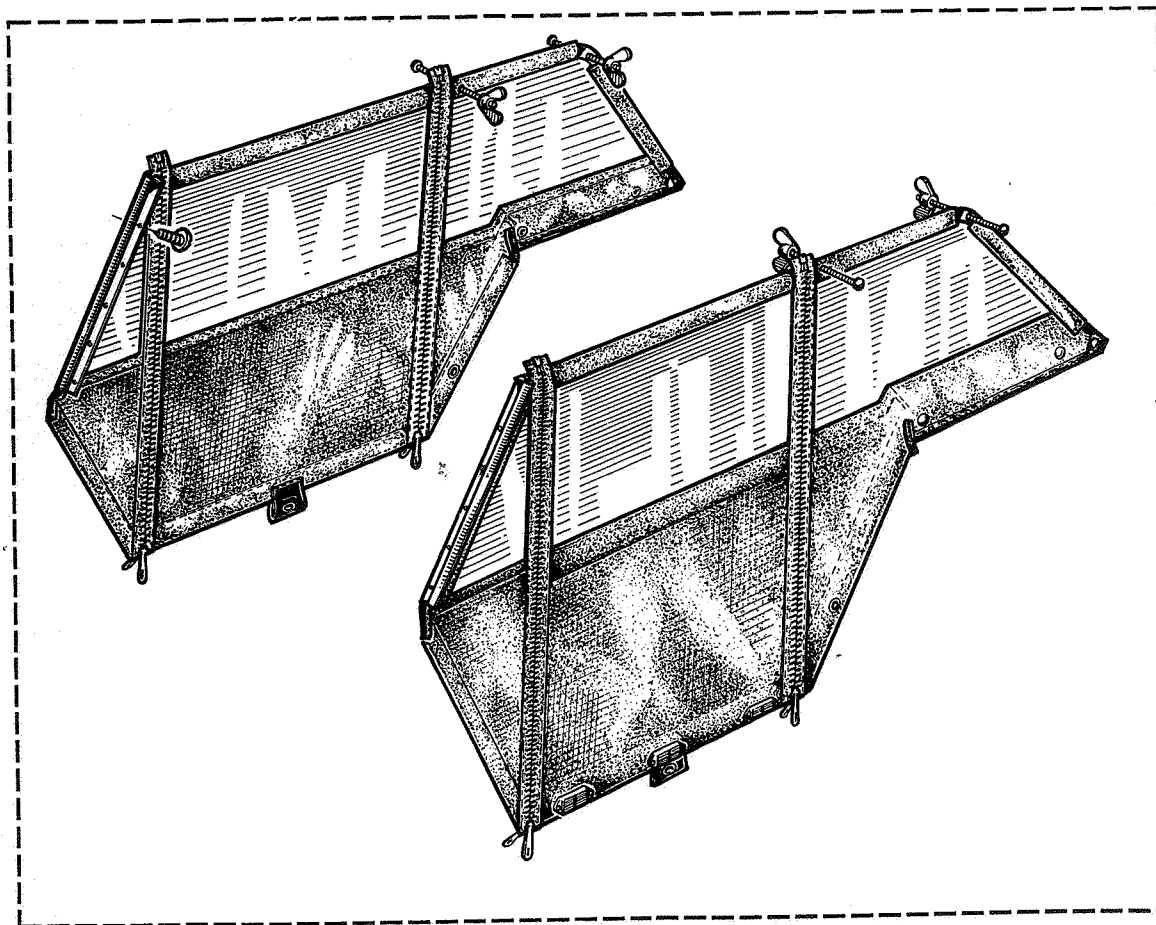
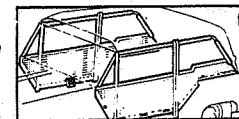

{ 60 00 017 152 (a)  
60 00 017 139 (b)

(a) R 1123 VEH n° 1 ⇨ VEH n° 598654 ☒ (132)  
(b) R 1123 VEH n° 598655 ⇨ VEH n° ... ☒ (132)

[132]  08...

(VB:  
(VB

(VE  
(VE

(V  
(V